

Commercial Applications

Commercial applications range from small offices and stores to larger complexes such as hotels, restaurants, office buildings, and shopping malls. A small, single-tenant office building, for example, would not have a large demand for power. In this case, all that may be required is a single-position meter socket and panelboard. Small-demand, multiple-tenant applications, such as found in a small strip mall, might also have a low demand for electrical power. In these cases, metering systems or modular meter centers, as discussed in the “Residential Applications” section, might satisfy the load requirements.

Typically, commercial applications have higher demands for electrical power than residential applications. Electricity is used in commercial applications for heating, cooling, and lighting on a much larger scale. Some commercial applications may also operate machinery such as elevators and small conveyors.



Busway

There are two methods to route power into a building or distribute power throughout a building. Electrical cable can be run inside conduit or busway can be used. The distribution system in a building frequently consists of a combination of busway and cable and conduit.

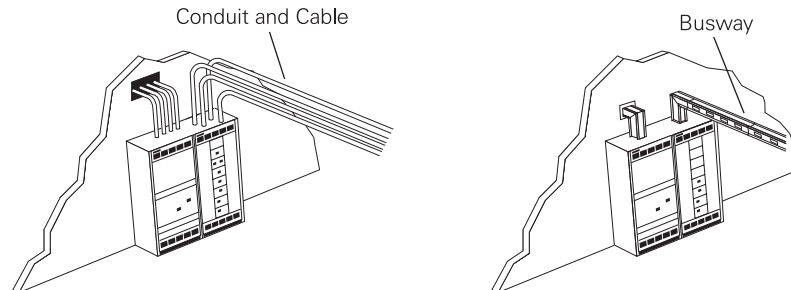

NEMA Definition

Busway, as defined by the National Electrical Manufacturers Association (NEMA), is a prefabricated electrical distribution system consisting of bus bars in a protective enclosure, including straight lengths, fittings, devices, and accessories.

Bus bars are the electrical conductors that carry power. The bars are individually insulated and enclosed in a housing. Siemens Sentron busway is illustrated below.

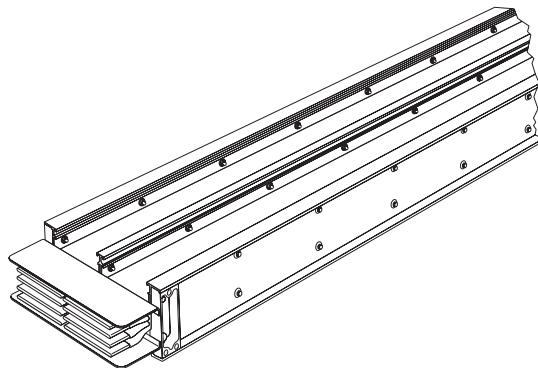

Service Entrance

Outdoor feeder busway is often used as service entrance conductors to bring power into a switchboard or panelboard. This may involve routing power from outside the building or from a transformer vault inside the building. For distribution inside the building indoor feeder or plug-in busway can be used.

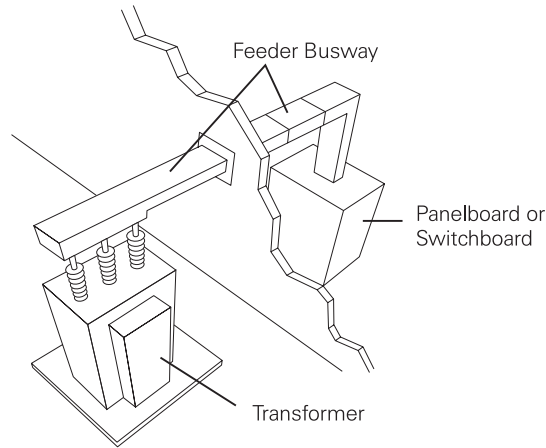

Busway Used in a Distribution System

A major advantage of busway is the ease in which busway sections are connected together. Electrical power can be supplied to any area of a building by connecting standard lengths of busway. It typically takes fewer man-hours to install or change a busway system than cable and conduit assemblies. Savings of 25 to 30% of the total installation cost are common when busway is used. Busway risers (vertical busway) can be installed economically in a high-rise building, such as the one illustrated below, where it can be used to distribute power to lighting and air-conditioning loads.

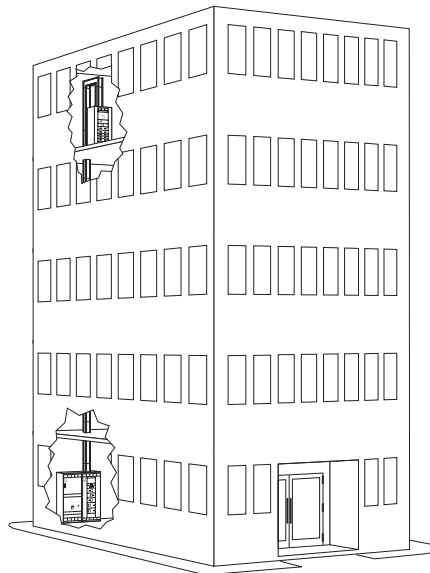

Power Distribution in Commercial Applications

Panelboards and switchboards can be used in commercial applications as service entrance equipment and for distribution of electrical power throughout the building. Although load centers, panelboards, and switchboards are similar in function and appearance, they are different products and designed to meet different needs. The following table shows how load centers, panelboards, and switchboards are defined. The *National Electrical Code*® (*NEC*®) makes no distinction between a load center and a panelboard.

| Load Centers | Panelboards | Switchboards |
|--|---|--|
| Used to control light, heat, or power circuits. | Used to control light, heat, or power circuits. | Large single panel, frame, or assembly of panels. |
| Placed in a cabinet or cutout box. | Placed in a cabinet or cutout box. | Not intended to be installed in cabinets. |
| Mounted on or in a wall. | Mounted on or in a wall. | May be accessible from the rear as well as the front. |
| Accessible only from the front. | Accessible only from the front. | Switches, overcurrent and other protective devices, buses, and instruments mounted on the face or inside of switchboard. |
| Typically rated 225 amps or less and 240 volts max. | Siemens panelboards are available with max ratings from 125 to 1200 amps, voltage ranges from 120 to 600 volts. | Siemens switchboards are available with max ratings up to 6000 amps at 600 volts. |
| Industry term used to identify a panelboard used in certain residential and light commercial applications. | | |

Panelboard Construction

Panelboards are constructed in a similar manner as load centers. Panelboards are more robust and able to handle the more demanding loads of commercial applications.

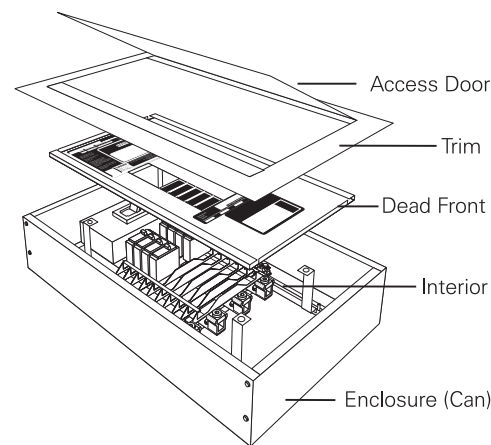

NEC® and *National Electrical Code*® are registered trademarks of the National Fire Protection Association.

Panelboards

Siemens manufactures a variety of panelboards to meet various distribution requirements. P1, SE, and S3 lighting and power panelboards are smaller in size and well suited to demands of commercial applications. P1 panelboards handle loads up to 400 amps. SE and S3 panelboards handle loads up to 600 amps. S4, S5, F1, and F2 power panelboards are designed for power applications up to 1200 amps.

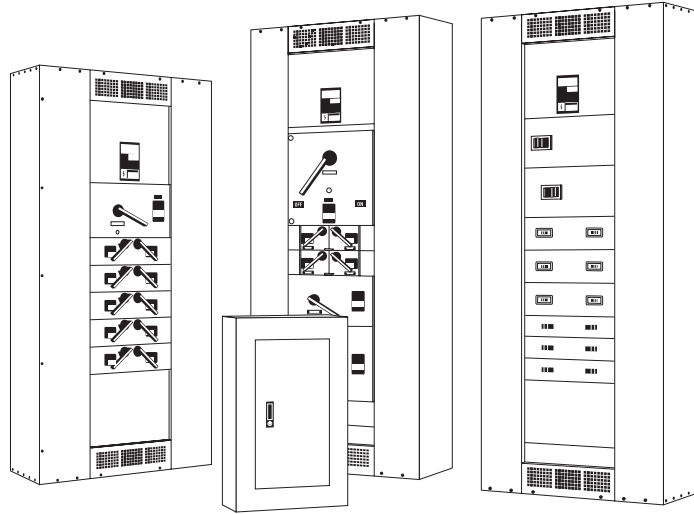

Switchboard Construction

Switchboards typically consist of a service section and one or more distribution sections. The service section can be fed directly from the utility transformer. In addition to the main disconnect, the service section usually contains utility or customer metering provisions.

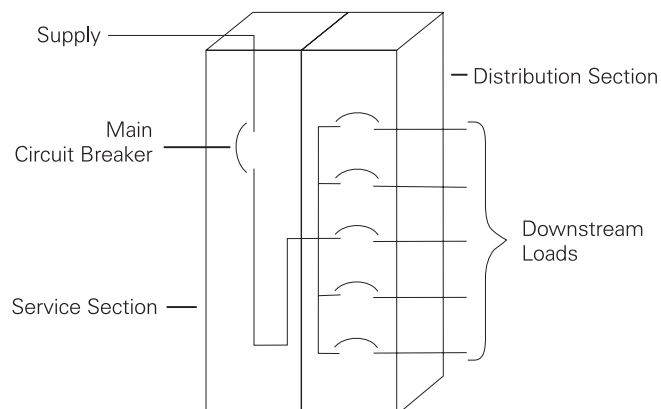

SB1, SB2, SB3

Siemens manufactures a variety of switchboards. The type of switchboard selected is determined by a variety of factors such as space, load, and environment. Sentron SB1, SB2, and SB3 are selected when space is a consideration. These switchboards are accessed from the front and most can be mounted against a wall. SB1, SB2, and SB3 switchboards can be found in a variety of commercial, institutional, and industrial buildings.

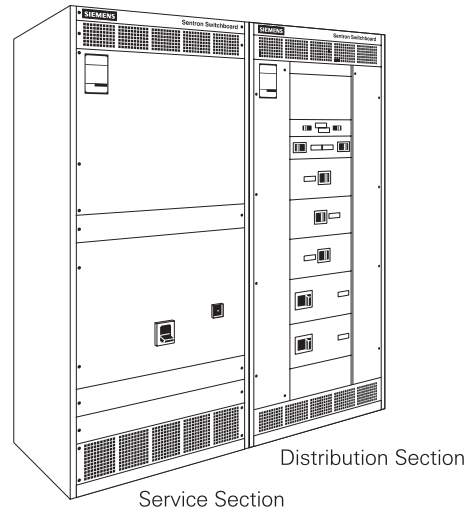

RCIII Switchboards

RCIII switchboards are rear connected and require rear access and are typically found in industrial applications.

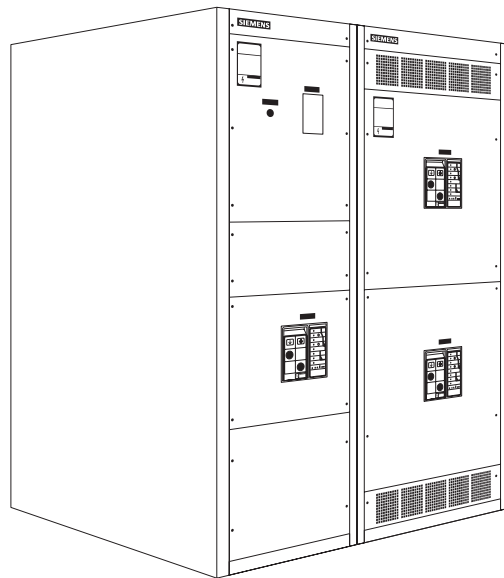

Super Blue Pennant

The Super Blue Pennant™ switchboard is designed as a service entrance switchboard. The main service disconnect and distribution devices are contained in a single unit. Super Blue Pennant switchboards are rated for 400, 600, or 800 amps.

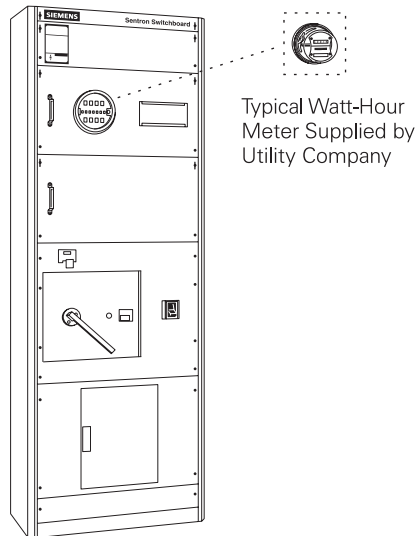

Commercial Metering

Commercial metering switchboards are designed for Switchboards applications where multi-metering is required. These applications include shopping centers, office buildings, and other commercial buildings with multiple tenants. Type SMM switchboards are designed to meet west-coast utility specifications. Type MMS switchboards are similar to the SMM switchboards, but utilize a ringless type meter, manual bypass, and no test blocks. The switchboard main service is rated up to 4000 amps at 480 volts, and service mains are rated up to 2000 amps for both types of switchboards. Commercial metering switchboards can be supplied with 2, 3, 4, or 6 sockets.

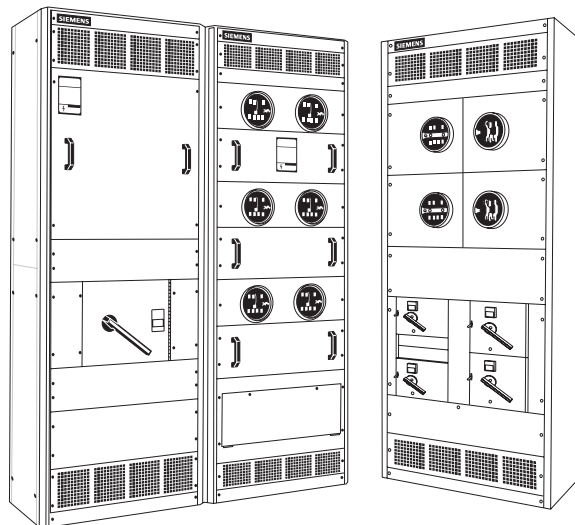

Type SMM Switchboard

Type MMS Switchboard

Panelboard Example

When choosing between a panelboard and a switchboard in commercial applications, it is not always clear which product you should choose. There are a number of factors to consider such as total load, routing of the electrical power throughout a building, and future expansion. For example, in a small commercial application 480 volts supplied by the utility is applied to the input of a panelboard. Various outputs are used to supply power throughout the facility. One output might be used to supply power to a second panelboard through a transformer which is used for lighting and electrical outlets. Another output might be used to supply power to a motor through a motor starter.

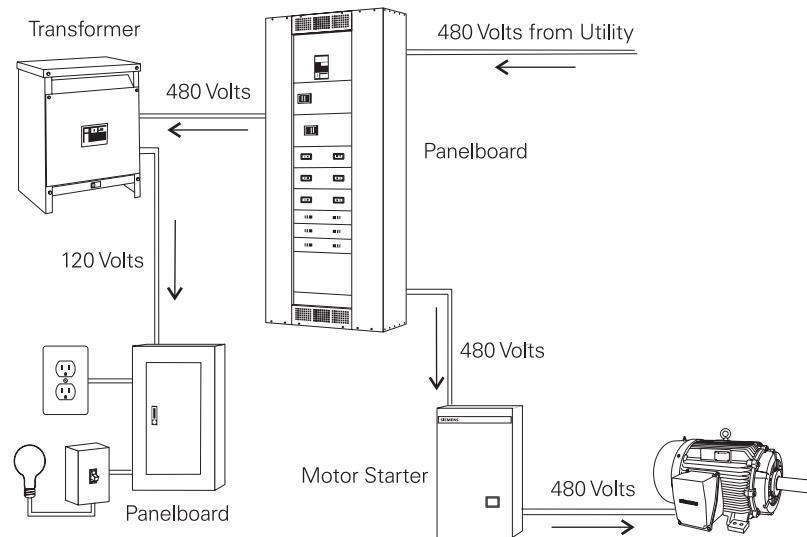

Switchboard Example

In larger or more demanding commercial applications, switchboards can also be used to distribute power. For example, 480 volts supplied by the utility is applied to the input of a switchboard. One output might be used to supply power to a small panelboard through a transformer which is used for lighting and electrical outlets. Another output might be used to supply power to a larger panelboard located further away or on another floor. This panelboard supplies power to another panelboard for lighting and receptacles in that area. In addition, the panelboard supplies power to control a motor.

